

# OmniPOD

Optimising LED lighting technology

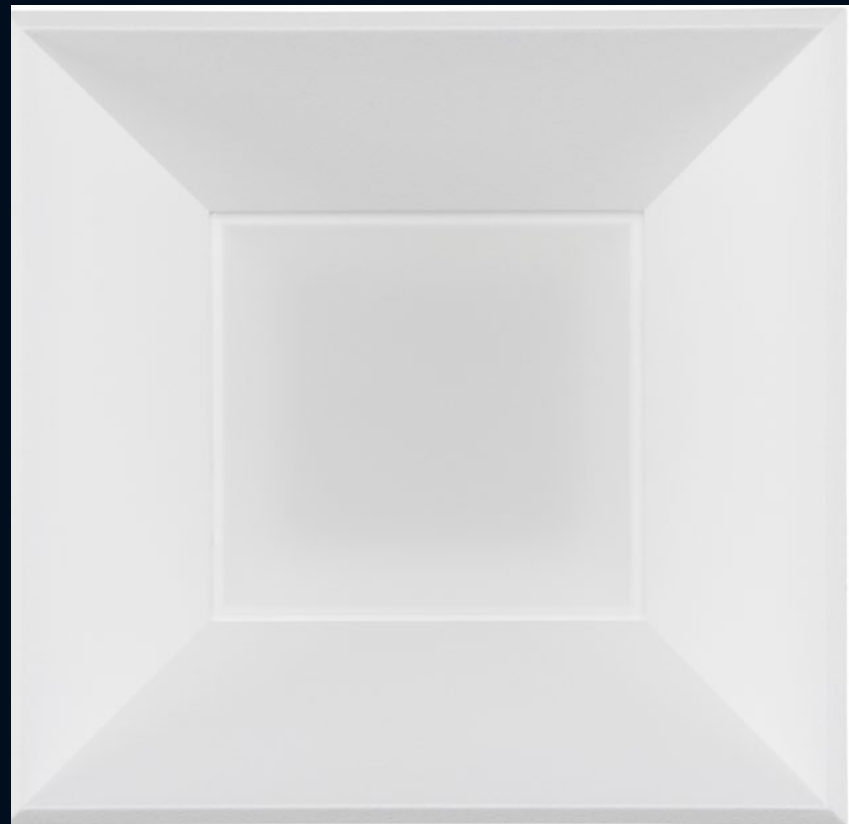

## The OmniPOD range

---

**POD design** Optimal performance **Smart lighting** 10-year warranty\*  
**Versatile** 26% more Energy Efficient\*\* **Customisable** Made in Australia

---

OMNIPOD  
PENDANT



OMNIPOD RECESSED  
- LINEAR

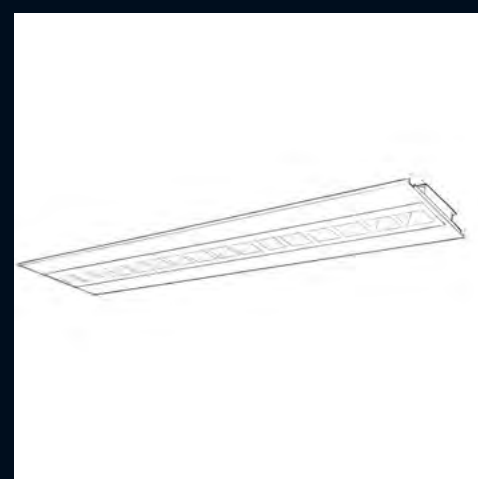

OMNIPOD RECESSED  
- SQUARE



OMNIPOD  
DOWNLIGHT

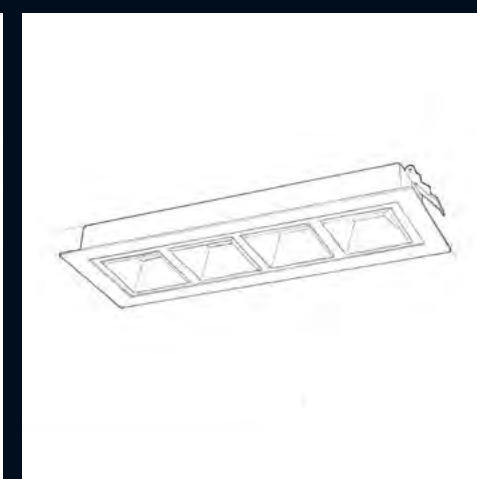

\*Applies to OmniPOD products with integrated smart sensors only.

\*\* All recessed OmniPODs are a minimum 26% more efficient than the previous generation.

# The OmniPOD brilliance



## THE POD

The POD design creates the perfect downward light while the complementary diffuser illuminates the space. Together they deliver the unique OmniPOD effect.

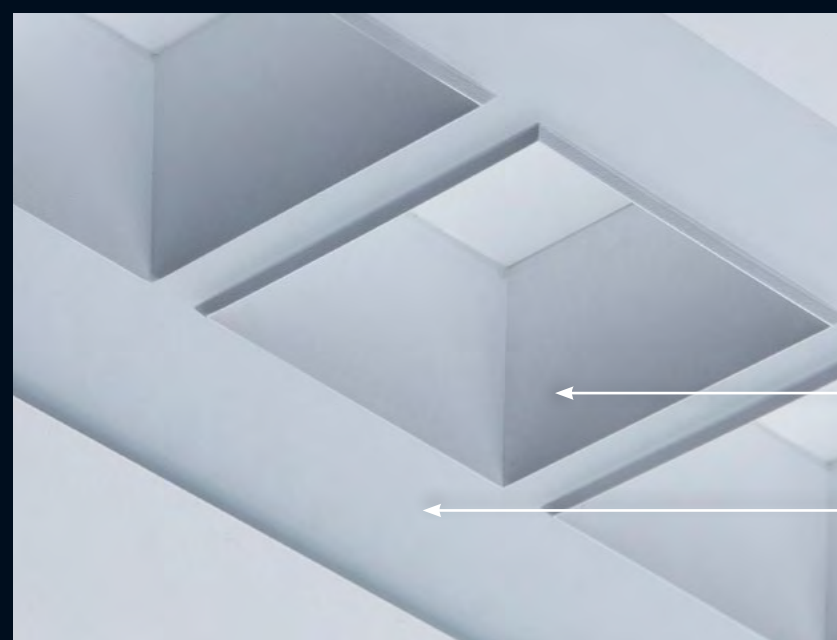

POD

DIFFUSER

## POD + DIFFUSER

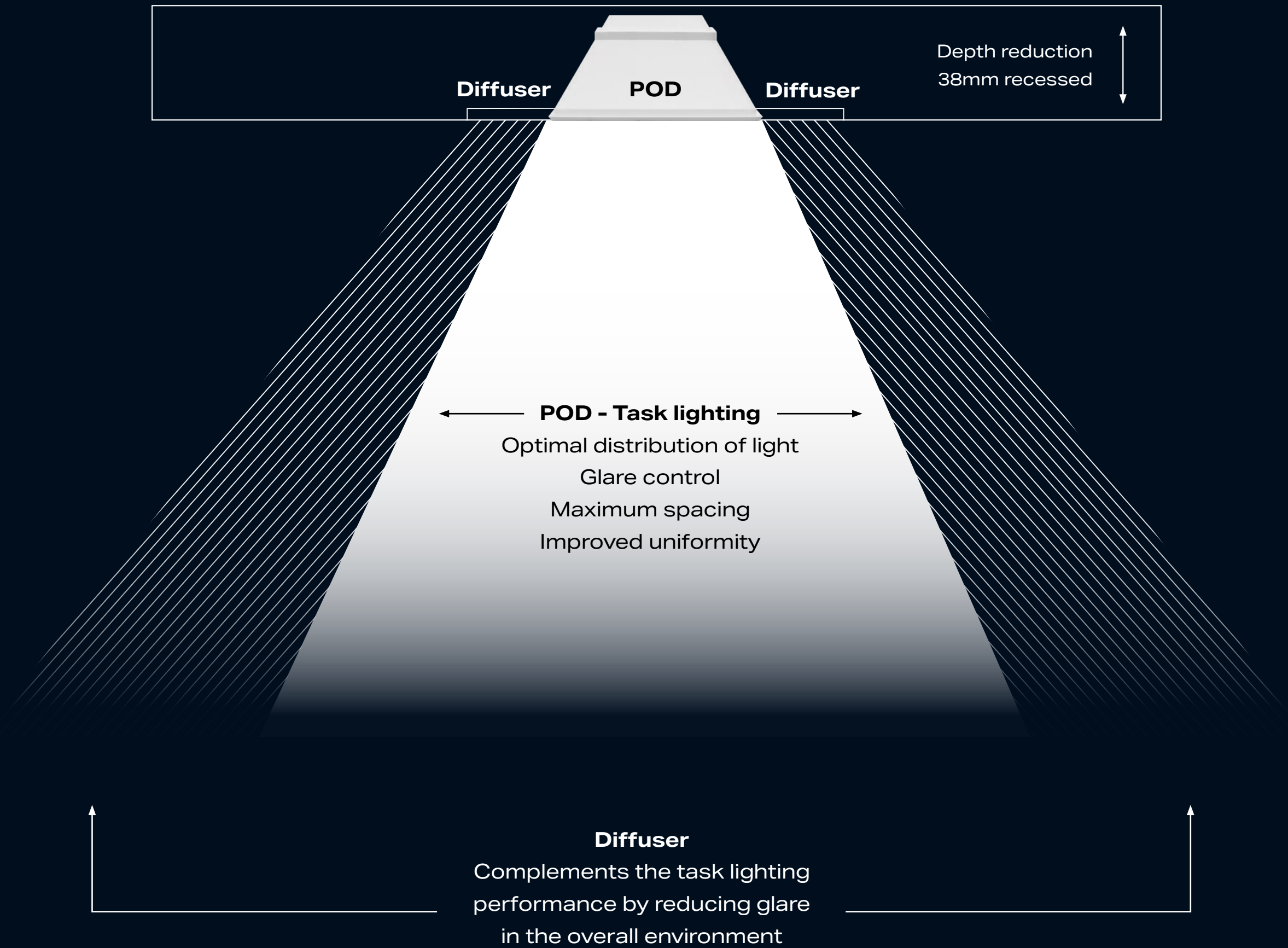

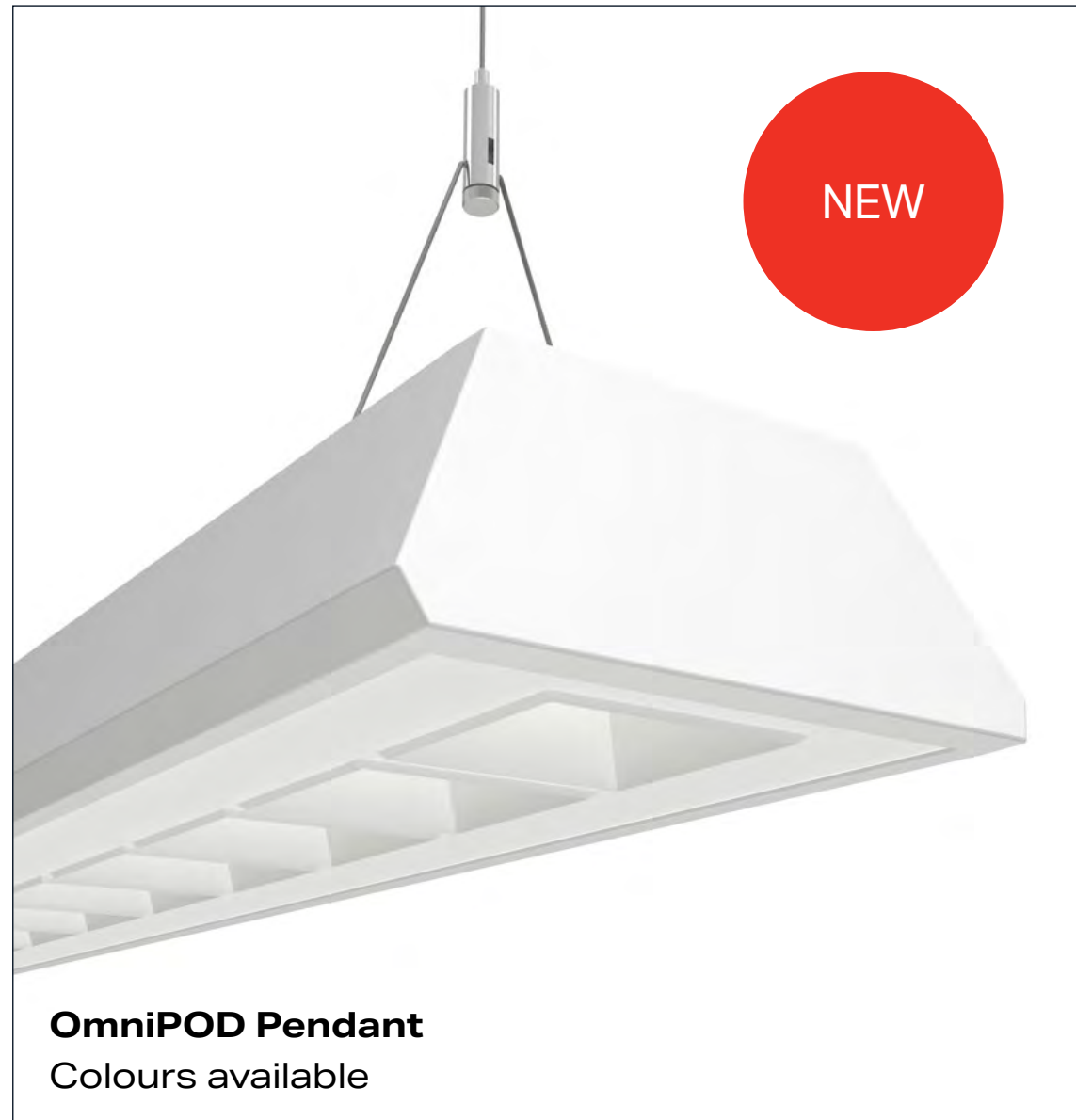

## OmniPOD range

The updated OmniPOD range features the latest LED technology and delivers an impressive 26%\* greater efficacy, significantly reducing electricity consumption. This translates to substantial cost savings and contributes to a greener planet. In addition to the efficiency gains, the OmniPOD range meets human-centric lighting standards by featuring low glare (UGR), CRI 90+ as standard, and optimised wide beam distribution – up to 3.2m spacing\*\*.

OmniPOD range now delivers an impressive 26%\* greater energy efficiency, significantly reducing electricity consumption.

### Energy Efficiency

	Efficacy
<b>OmniPOD Pendant</b>	144 lm/W
<b>OmniPOD Recessed - Linear</b>	140 lm/W
<b>OmniPOD Recessed - Square</b>	138 lm/W
<b>OmniPOD Downlight</b>	113 lm/W

\*All recessed OmniPODs are a minimum 26% more efficient than the previous generation. OmniPOD Downlight is 26% more efficient than previous model.

\*\* Based on a 2.7m ceiling height.



## New OmniPOD pendant



## Customise with colour



### **OmniPOD Pendant**

Available in your choice of colour, offering endless possibilities. Seamlessly blend with the ceiling, introduce a bold contrast, or feature corporate brand colour



# Customise to suit your project

Integrate **SMART LIGHTING** to achieve maximum energy efficiency. Connect Organic Response and control via a smartphone or tablet.

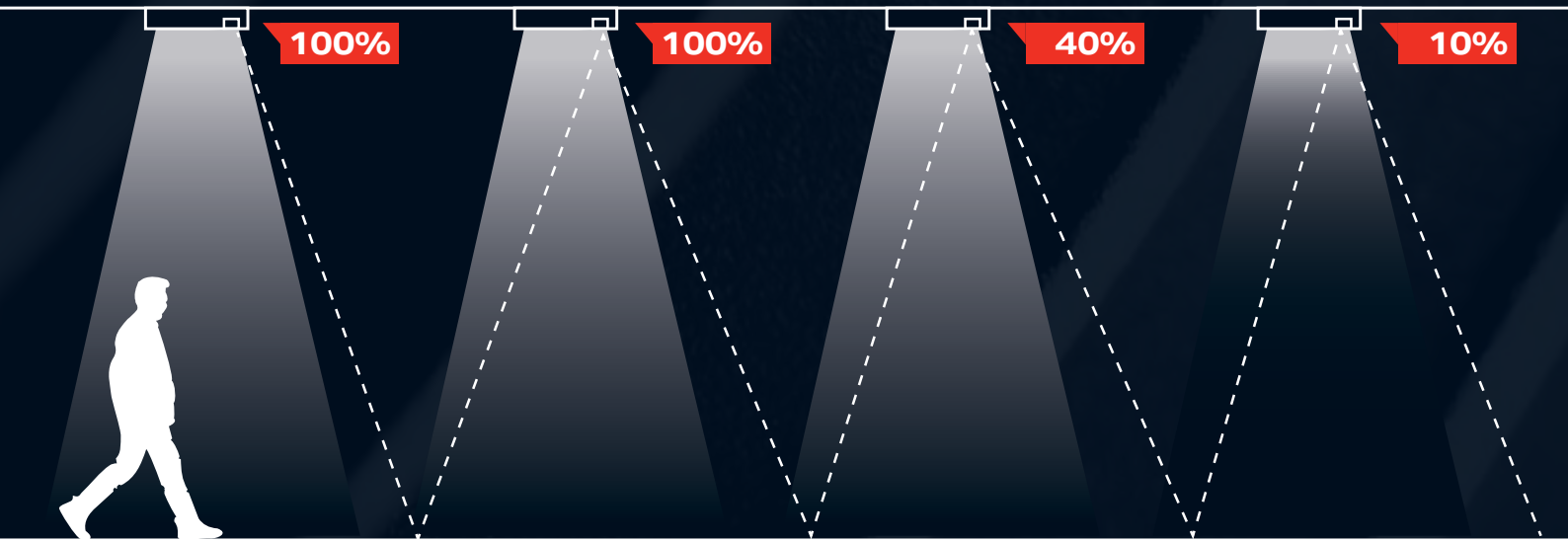

**WIPEDOWN** for hygiene applications such as medical and kitchen spaces.

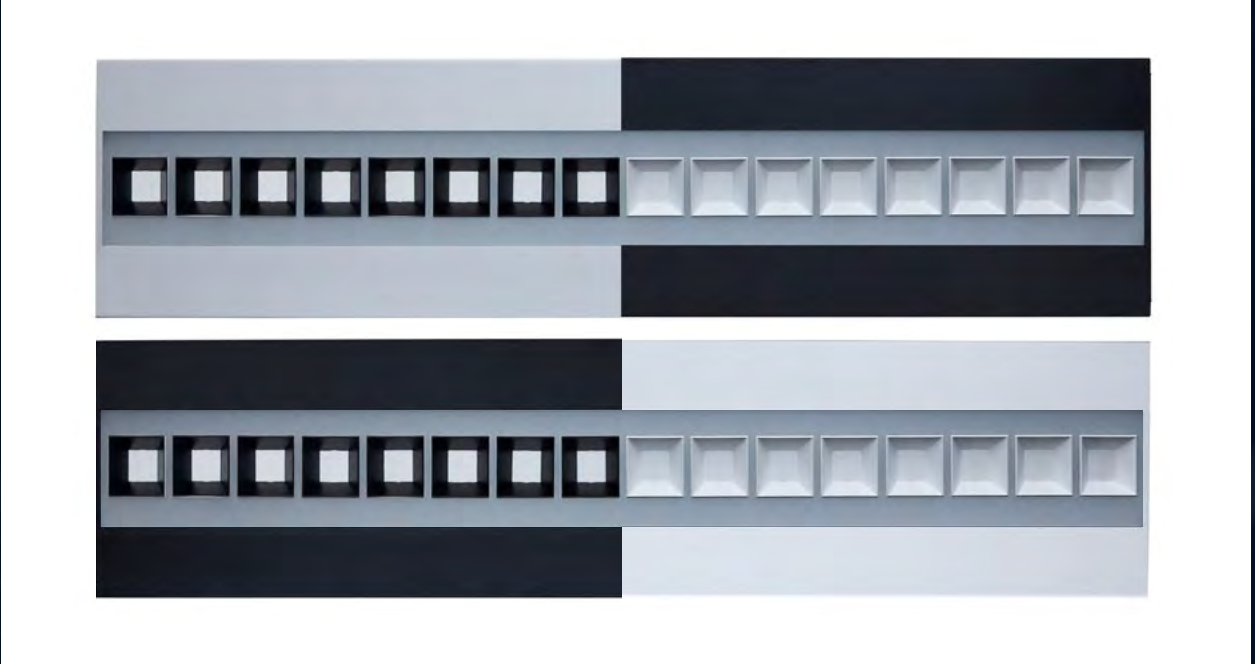

**MIX N MATCH –** POD and frame colours are interchangeable in – White/White, Black/Black, White/Black, Black/White.



**AIR SLOTS** allow additional room air circulation. OmniPOD products fit all air boot sizes.

**CUSTOM LENGTHS + SIZES** mean you can fit an OmniPOD into all applications e.g. Pendants available up to 2400mm in length.

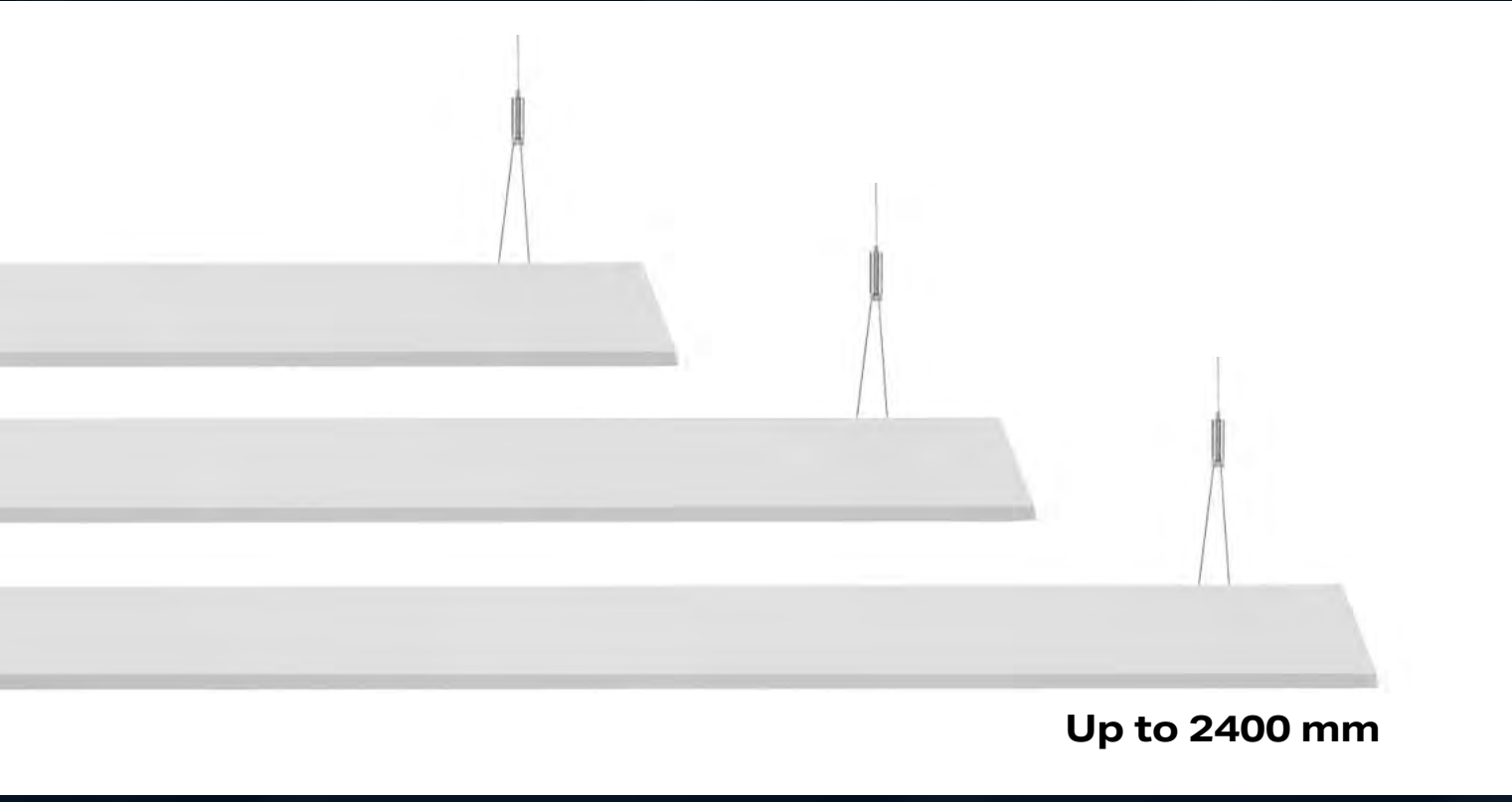



## Customise your colour temperature

### TUNEABLE WHITE

Add Tuneable White to provide flexibility

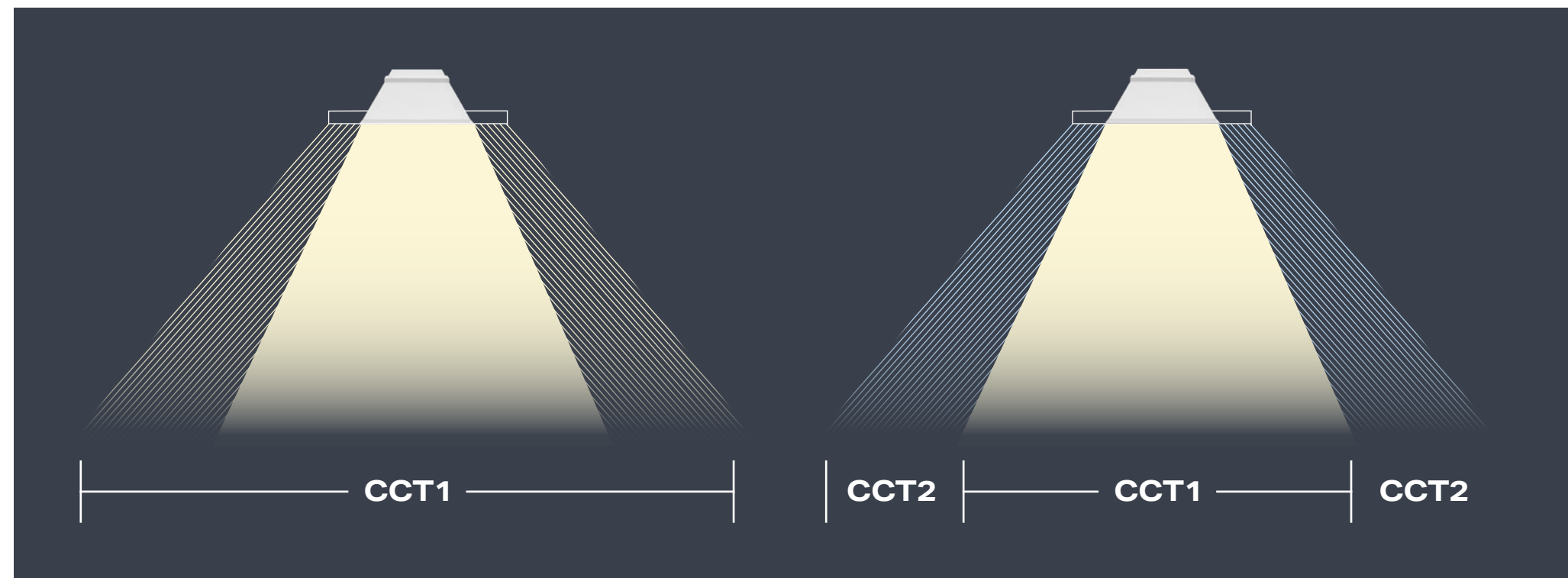

### TUNEABLE DUO<sup>1</sup>

The inner (POD) and outer (Diffuser) operate as one. Fully adjustable from 2700-6500K, CRI 90+.

### TUNEABLE DUO<sup>2</sup>

The inner (POD) and outer (Diffuser) operate independently. Each fully adjustable from 2700-6500K, CRI 90+.

### FIXED CCT

All fixed CCT OmniPODs come in either 3000K or 4000K as standard.

## Organic Response smart lighting

### A SMART WAY TO REACH SUSTAINABILITY TARGETS

Organic Response is a flexible and innovative wireless 'plug & play' lighting control system that perfectly complements the OmniPOD range. Allowing each individual luminaire to make lighting decisions based on the presence of occupants in its immediate vicinity, ambient light levels, and information it receives from its neighbouring luminaires., Organic Response reduces energy consumption by up to 40%.







### CERTIFICATIONS

OmniPOD products with Organic Response will significantly contribute to your project achieving certifications such as a Green Star rating, NABERS, WELL, ISO 50001 EnMS, and Passivhaus.

Once installed, Organic Response reduces energy consumption by up to 40%

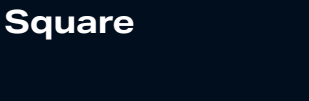

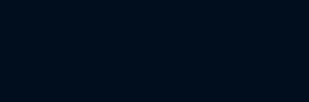
# OmniPOD Specification Guide

	Body Colour	POD Colour Options	Nominal Size [mm]			Max Target Spacing @ E <sub>h</sub> =320lux	Lighting Type Options		Controls			Emergency Option <sup>(2)</sup>	CLO Lifetime (L100B50) <sup>(3)</sup>	CRI/ R9	IP Rating <sup>(4)</sup>	Efficacy [lm/W]	UGR	CCT	Wipedown Film	Mounting Options <sup>(6)</sup>	Air Handling		
			Length	Width	Height		Direct	Direct+ Indirect	OR	DALI	Other <sup>(1)</sup>												
 <b>OmniPOD Pendant</b>	White, Black, Custom colours available	White / Black	1200, 1500, 2400	150	70	-		Y	Y	Y*		N	50,000	90+/50	IP40 or IP44 <sup>(5)</sup>	144	16	4000K, 3000K, Tuneable White DUO <sup>1</sup> / DUO <sup>2</sup>	Y*	Suspended	N		
 <b>OmniPOD Linear</b>			600, 1200, 1500	300	38	2.4m x 3.2m		N	Y*	Y		Y*								140	19	T-Bar, PC, SM	Y*
 <b>OmniPOD 150</b>			600, 1200, 1500	150	38	2.4m x 3.0m	Y	N	Y	Y	Y*	Y*								140	19	T-Bar, PC, SM	N
 <b>OmniPOD 6x6 square</b>			600	600	38	2.4m x 2.4m		N	Y	Y	Y*	Y*								138	19	T-Bar, PC, SM	Y*
 <b>OmniPOD 6x6 2-row</b>			600	600	38	2.4m x 2.4m		N	Y	Y	Y*	Y*								138	16	T-Bar, PC, SM	Y*
 <b>OmniPOD Downlight</b>			300	100	38	-		N	Y	Y		N								113	19	T-Bar, PC, SM	N

KEY - Y: Standard Y\*: Option N: Not Available

NOTES: 1. Other control options, including non-dim, are available. 2. Maintained DALI monitored, Maintained Non-monitored, and custom options are available. 3. The Constant Light Output (CLO) feature ensures no lumen depreciation until the luminaire reaches its L100B50 lifetime (cumulative usage hours). 4. Luminaires with an Organic Response node are rated IP20 from the room side, regardless of the original IP rating. 5. With Wipedown option. Wipedown layer provides IP44 from the room side in Linear, Square and Downlight variants with a ceiling side of IP40. Pendant with wipedown is rated IP44 from all directions. 6. Kits sold separately



eaglelighting.com.au  
info@eaglelighting.com.au  
Contact us today

## AUSTRALIA

Victoria  
Head Office  
17-19 Jets Court  
Melbourne Airport 3045  
(03) 9344 7444

New South Wales  
Level 1  
71-73 Alexander Street,  
Crows Nest 2065  
(02) 9420 5799

Queensland  
53 Caswell Street  
East Brisbane  
QLD 4169  
(07) 3891 0744

Australian Capital  
Territory  
0411 889 406

Western Australian  
(Distributor)  
H.I. Lighting  
111 Broadway  
Bassendean  
WA 6054  
(08) 9377 1322

South Australia  
(Distributor)  
Buckford Illumination  
Group, Unit 3,  
169 Goodwood Road  
Millswood SA 5034  
0448 064 412

Tasmania  
(Distributor)  
Southern Lighting  
34 Federal Street  
North Hobart  
TAS 7000  
(03) 6231 5599

## NEW ZEALAND

Auckland  
Citigroup Centre,  
23 Custom St East  
Auckland Central 1010  
New Zealand  
0800 324 374

Lower North Island  
Wellington  
021 597 900



A Fagerhult Group Company